

# Data Sheet



Article number: 12512600030500  
Description: KLEE-coil 512 600 030.500  
M3 Stainless 1.4305

## Measures

---

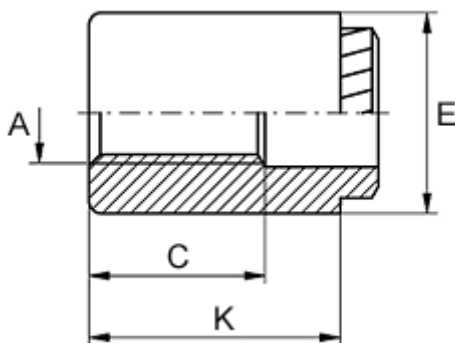

Female thread A	= M3
Height K	= 12
Hole diameter +0.1	= 4.2
Min distance to edge	= 2.4
Min material thickness	= 1.5
Outer diameter E	= 7
Thread length	= 9